

# Happy D.2 Plus # HP 4963 L/R

## Instrucciones de montaje

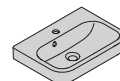
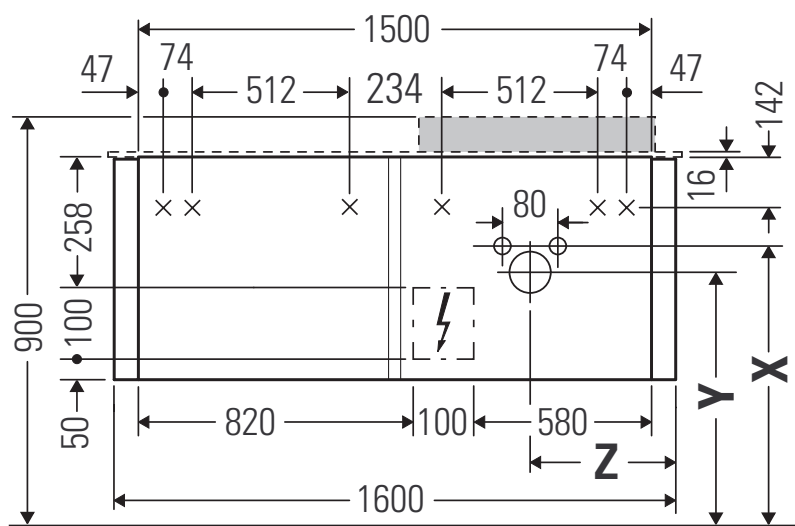
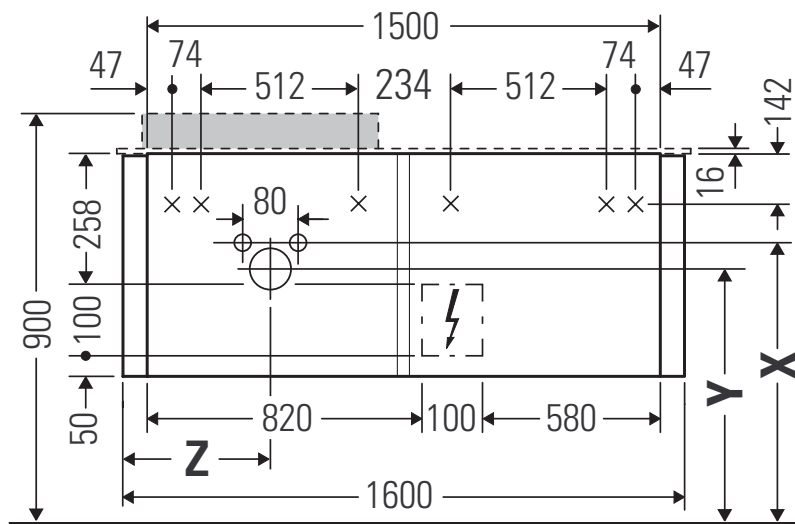

	Z mm	X mm	Y mm
#231860	400	655	605
#231865	400	655	605

### Indicaciones de uso

La serie de muebles de baño cumple las normas y directivas válidas en el momento de su entrega y se ha concebido para su uso en baños. Hay que evitar que se mojen directamente con agua, por ejemplo, durante la ducha.

Nos reservamos el derecho a efectuar mejoras técnicas y modificaciones de aspecto en los productos representados.

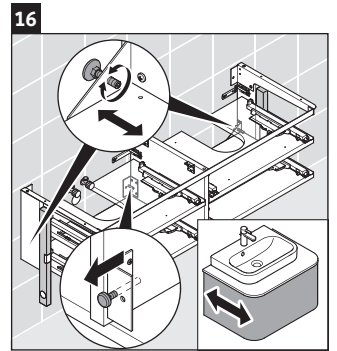
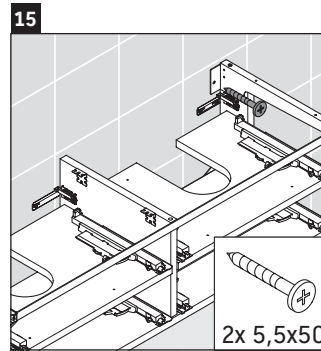
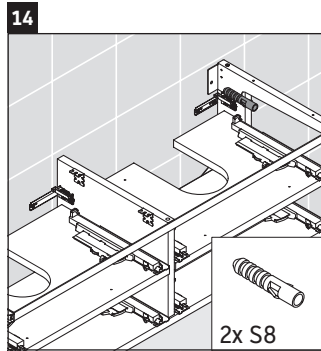
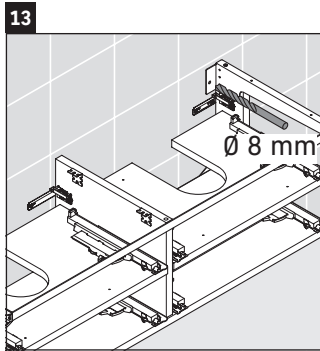
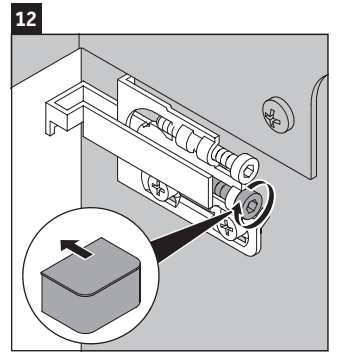
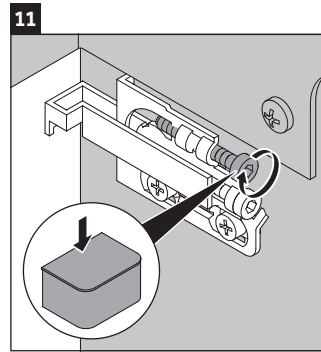
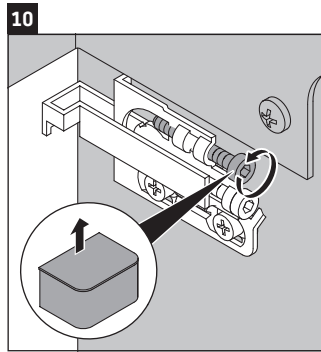
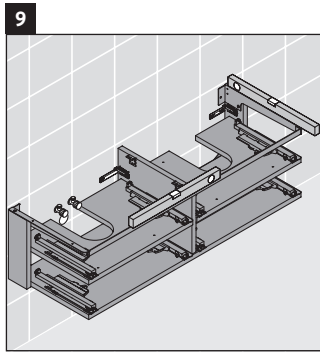
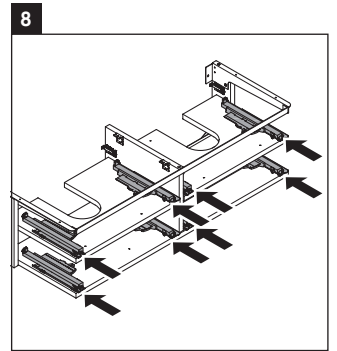
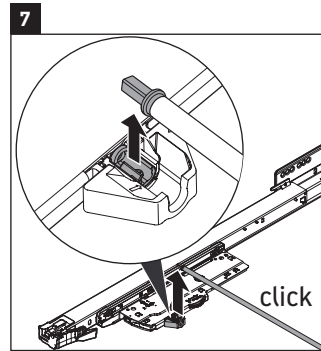
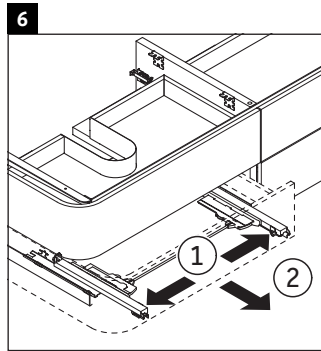
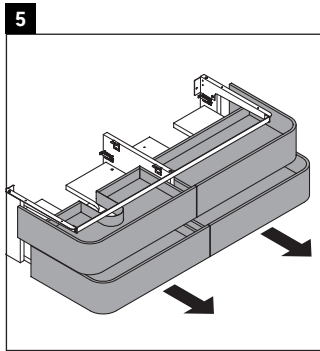
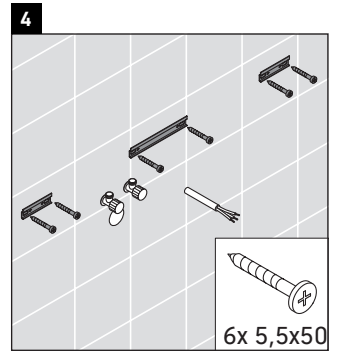
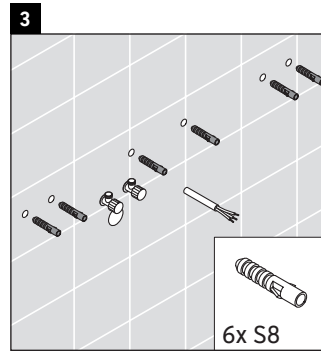
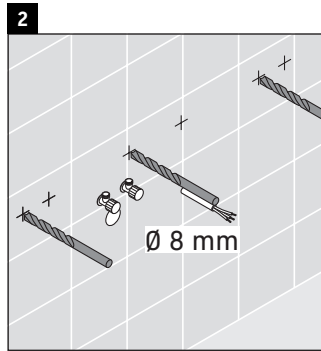
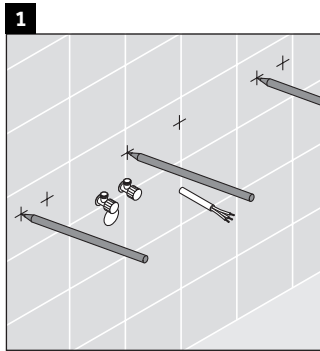
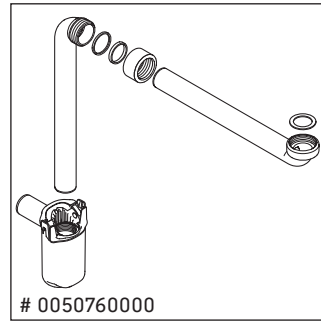
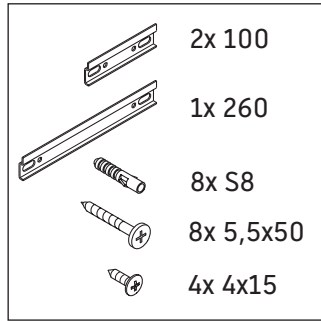
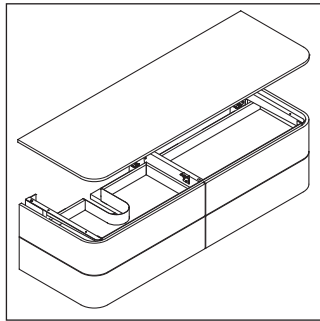

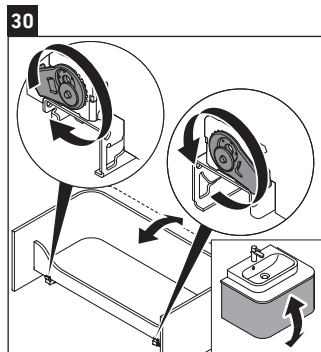
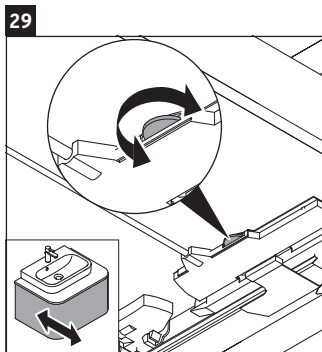
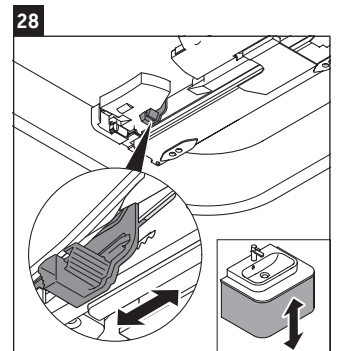
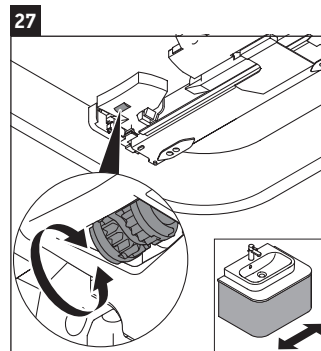
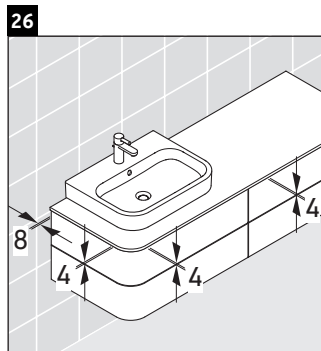
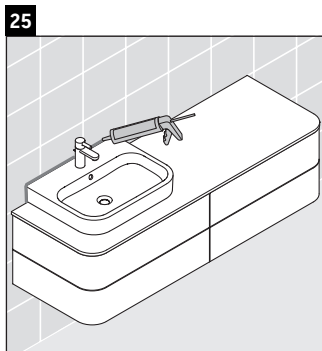
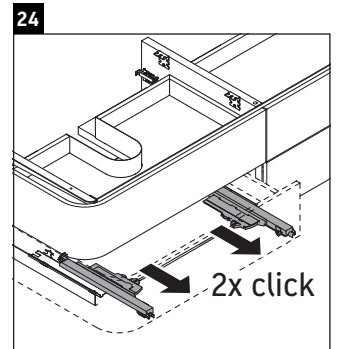
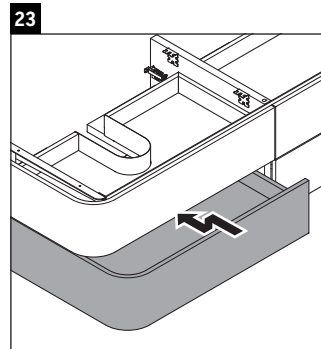
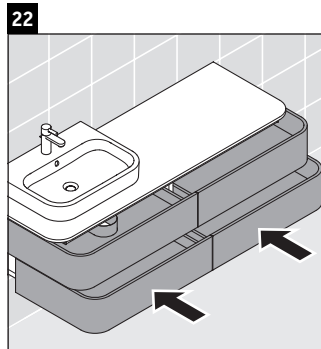
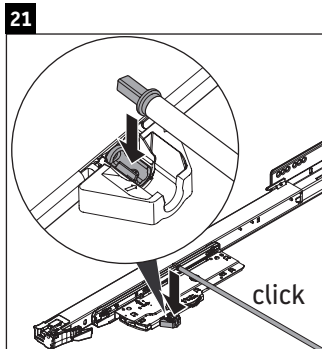
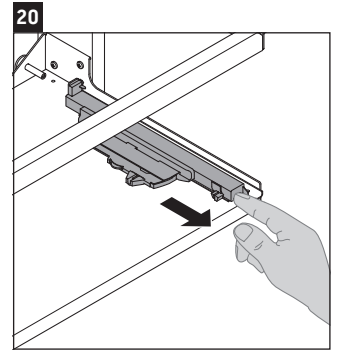
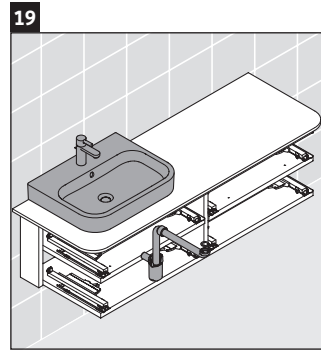
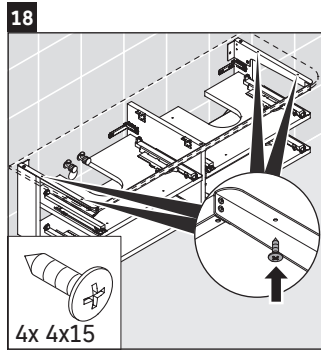
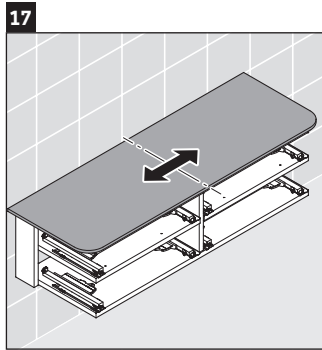

**Duravit AG**  
P.O. Box 240  
Werderstr. 36  
78132 Hornberg  
Germany  
Phone +49 78 33 70 0  
Fax +49 78 33 70 289  
info@duravit.com  
www.duravit.com

