

DuraStyle

DS 5329

Instrucciones de montaje

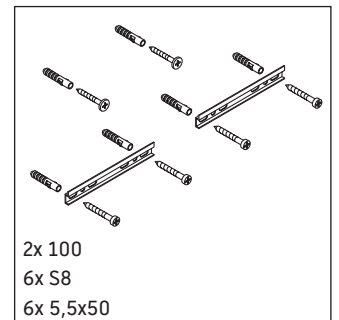
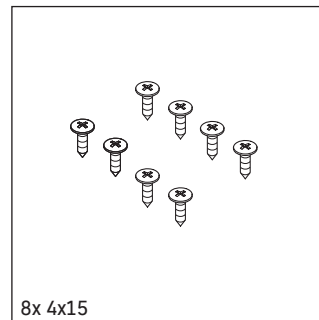
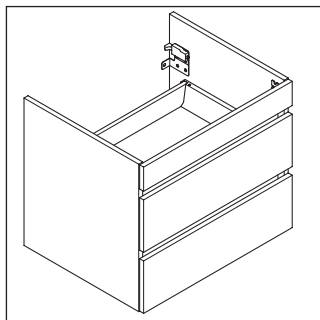
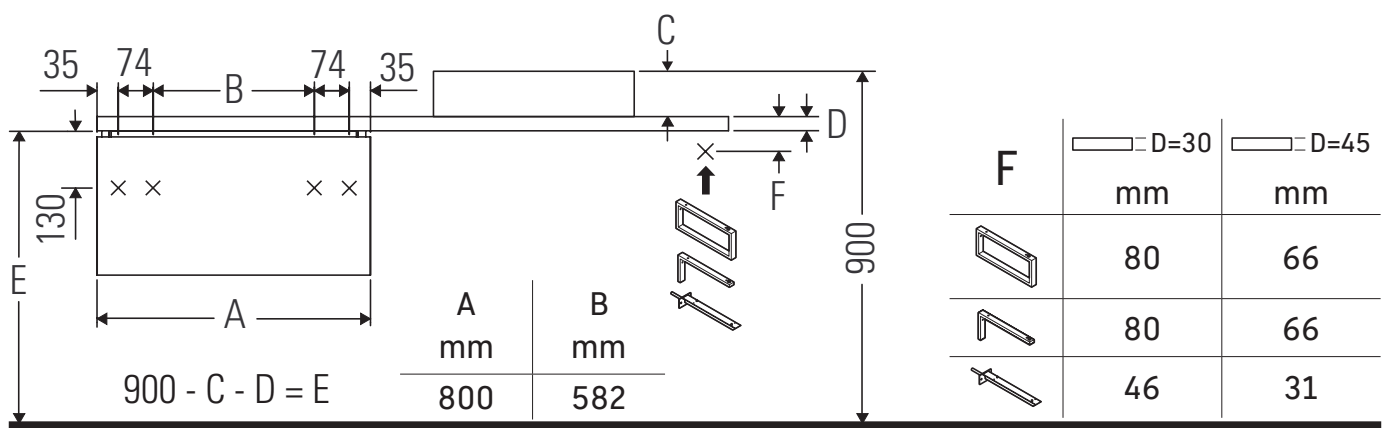

¡Observar las medidas de perforación!



¡Observar el resto de instrucciones de montaje!

Indicaciones de uso

La serie de muebles de baño cumple las normas y directivas válidas en el momento de su entrega y se ha concebido para su uso en baños. Hay que evitar que se mojen directamente con agua, por ejemplo, durante la ducha.

Las cerámicas más anchas de 600 mm tienen que fijarse en la pared.

Nos reservamos el derecho a efectuar mejoras técnicas y modificaciones de aspecto en los productos representados.

