

Happy D.2 Plus

HP 4974

Instrucciones de montaje

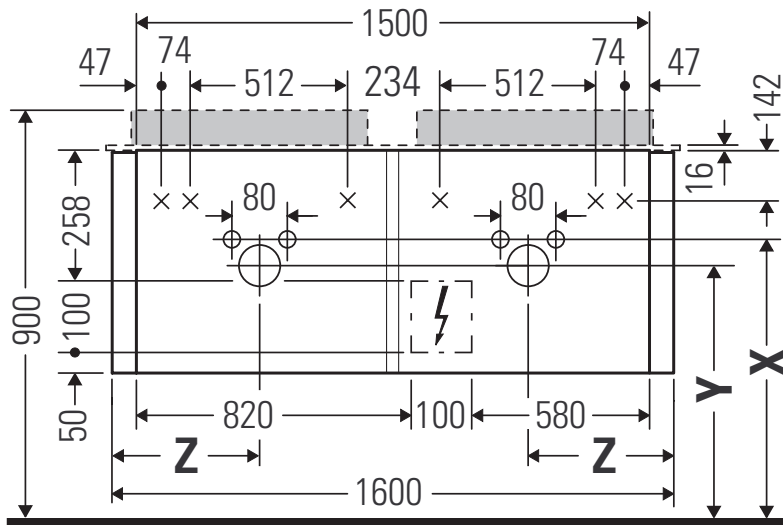
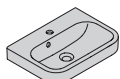

	Z mm	X mm	Y mm
#231440	400	660	610
#231460	400	660	610
#231560	400	655	605
#235940	400	695	645
#235960	400	695	645
#236060	400	665	615

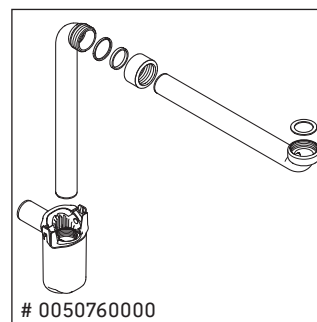
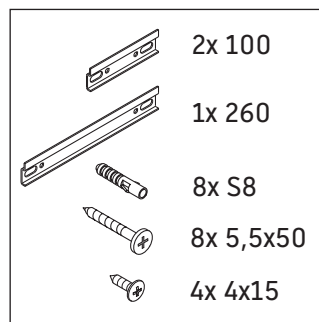
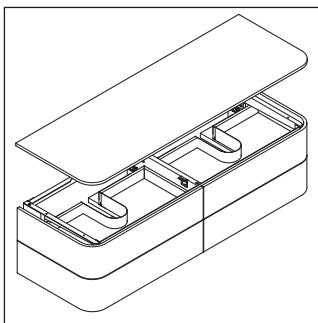

Indicaciones de uso

La serie de muebles de baño cumple las normas y directivas válidas en el momento de su entrega y se ha concebido para su uso en baños. Hay que evitar que se mojen directamente con agua, por ejemplo, durante la ducha.

Nos reservamos el derecho a efectuar mejoras técnicas y modificaciones de aspecto en los productos representados.

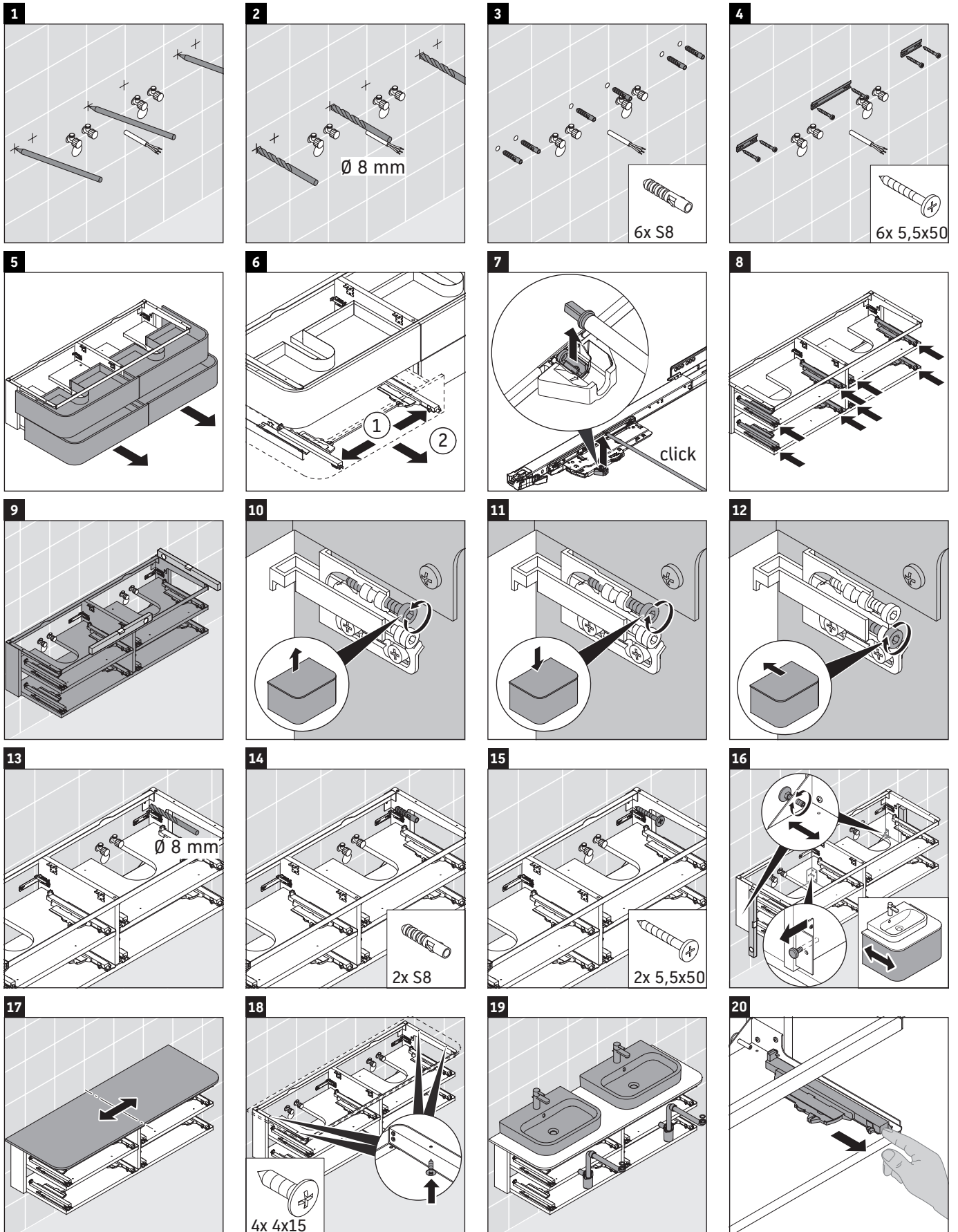

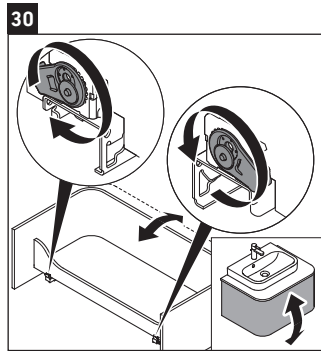
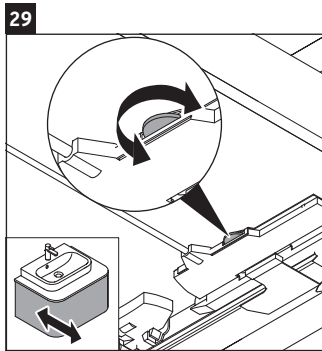
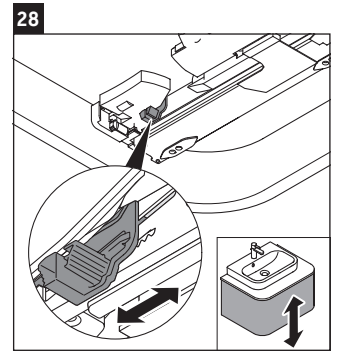
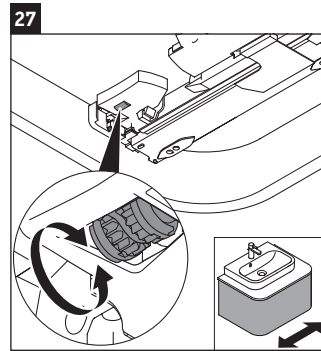
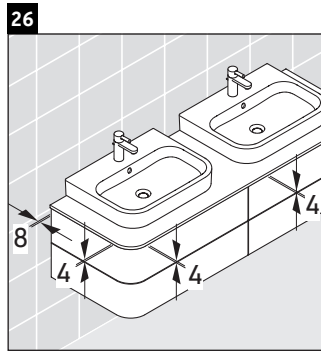
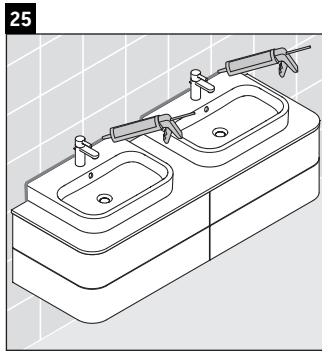
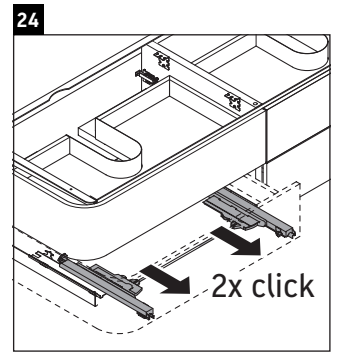
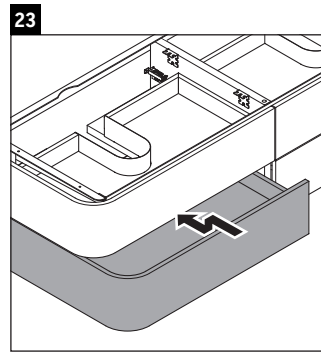
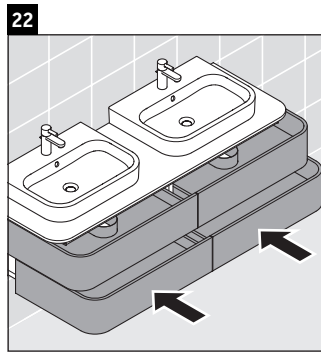
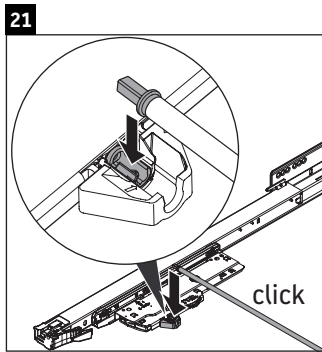

Duravit AG
P.O. Box 240
Werderstr. 36
78132 Hornberg
Germany
Phone +49 78 33 70 0
Fax +49 78 33 70 289
info@duravit.com
www.duravit.com

