

L-Cube

LC 4877

Instrucciones de montaje

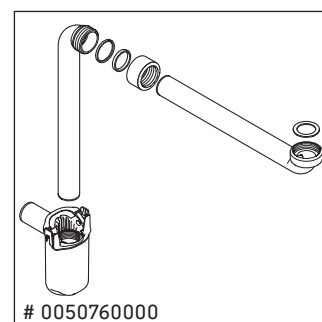
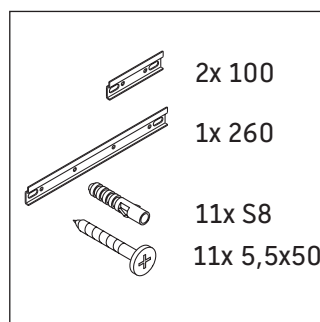
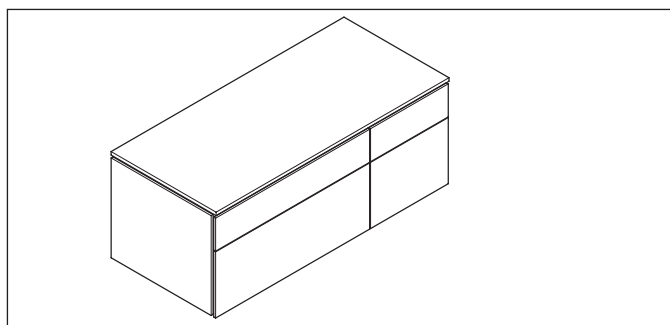
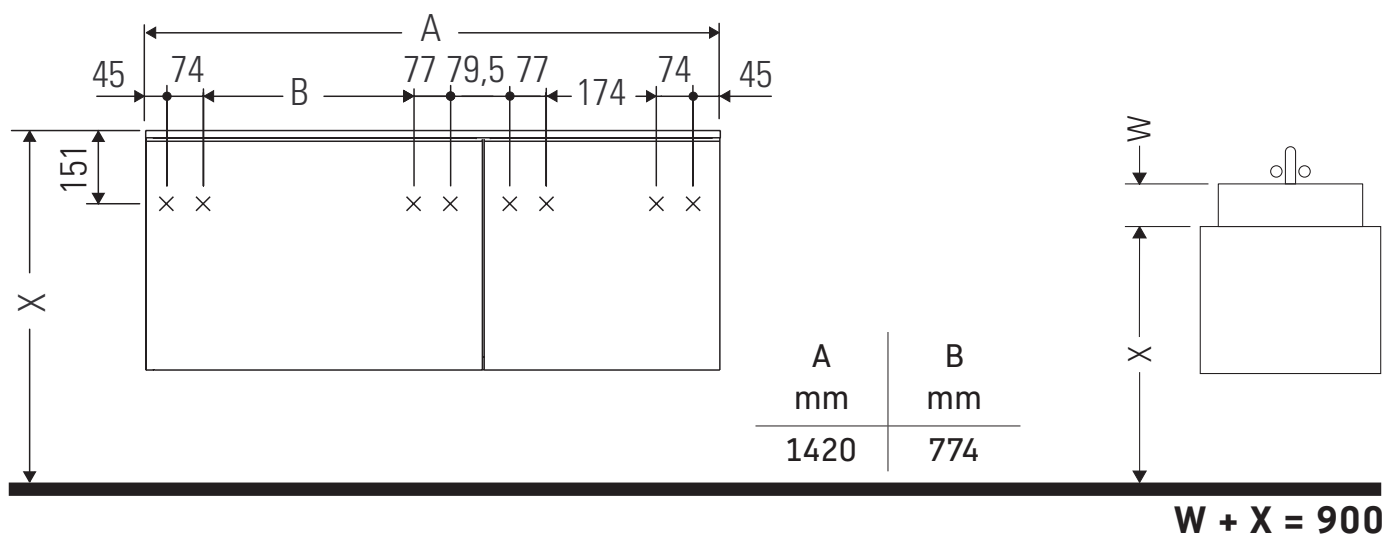

Indicaciones de uso

La serie de muebles de baño cumple las normas y directivas válidas en el momento de su entrega y se ha concebido para su uso en baños. Hay que evitar que se mojen directamente con agua, por ejemplo, durante la ducha.

Nos reservamos el derecho a efectuar mejoras técnicas y modificaciones de aspecto en los productos representados.

